

933-07x

Lv7 2018-r4

Modelo-model:

Kit 4 soportes V

Lote/Lot/Lot/Lot:



Peso/Weight/Poids/
Gewicht:

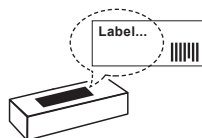

Max: 100 kg

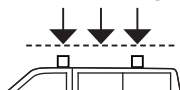

Código Homologación CEE
EEC Type Approval Number



26 R- 03 3022



26 R- 03 3024



CITY CRASH (✓)
According to ISO/ P. AS 11154:2006

P.I. Las Salinas II
14960 - Rute - Spain

- Instrucción de montaje** Kit fijación
- Assembly instructions** Fixation Kit
Read frst!
- Instruction de montage** Kit fixation
- Montageanleitung** Stützfuß-Kit
Zuerst lesen!
- Instruções de montagem** Kit fixação
- Instrukcja montażu** Element mocuj cy
Najpierw przeczytaj!
- Montážní návod** Fixa ní kit
t te pozorní !
- Szerelési Utasítás** Rögzít készlet
El ször olvasd el!
- Instructiuni de montaj** Kit de fixare
Intai cititi!
- Detaljne upute** Kit za montažu
Prvo pročitati!
- Διαβάστε προσεκτικά τις** (it)
μ
- Öncelikle montaj:** Montaj kiti
Talimatlarını okuyunuz!
- Инструкции по монтажу**
- Istruzioni di montaggio** Kit di fssaggio
- Montagehandleiding** Bevestigingsset
Eerst lezen!
- Navodila za sestavljanje** Kit za pri vrstitev
Preberite!



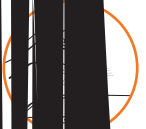

Lote
Lot

01/14

01/15

01/15

01/15

2. 



35x35 mm



52x35 mm
Aluminium



pág. 3,4,5,6



pág. 7,8,9



pág. 10,11,12,13

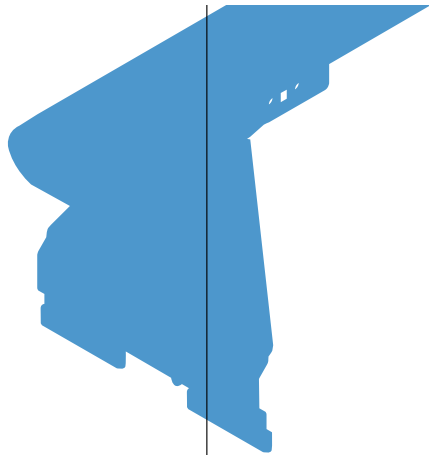

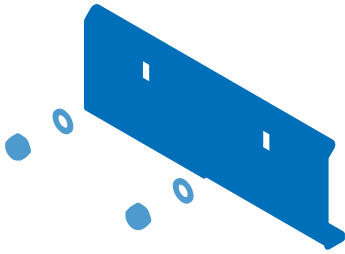

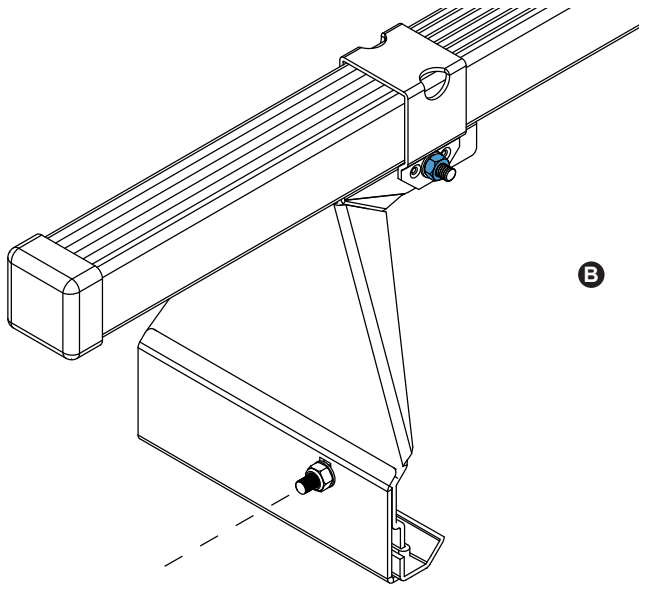

B

B

7. 

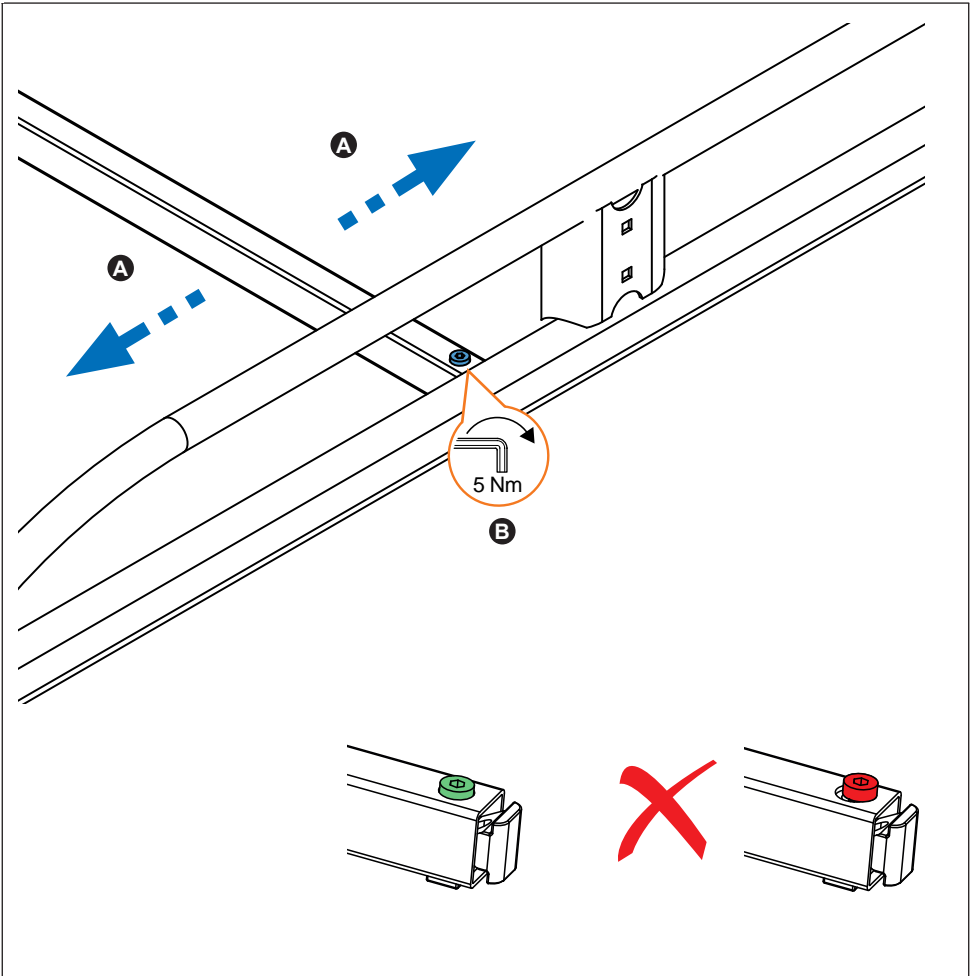
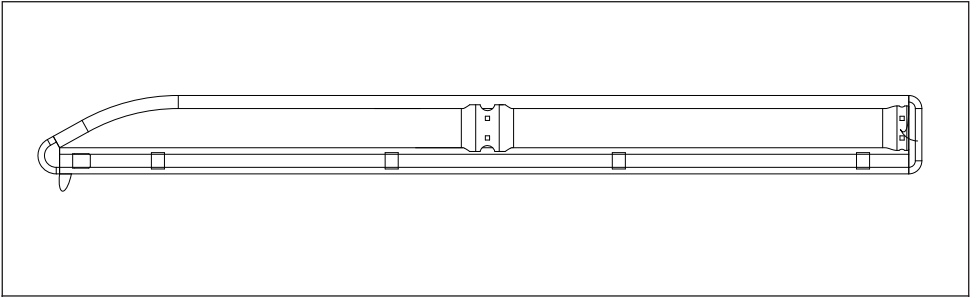

8.

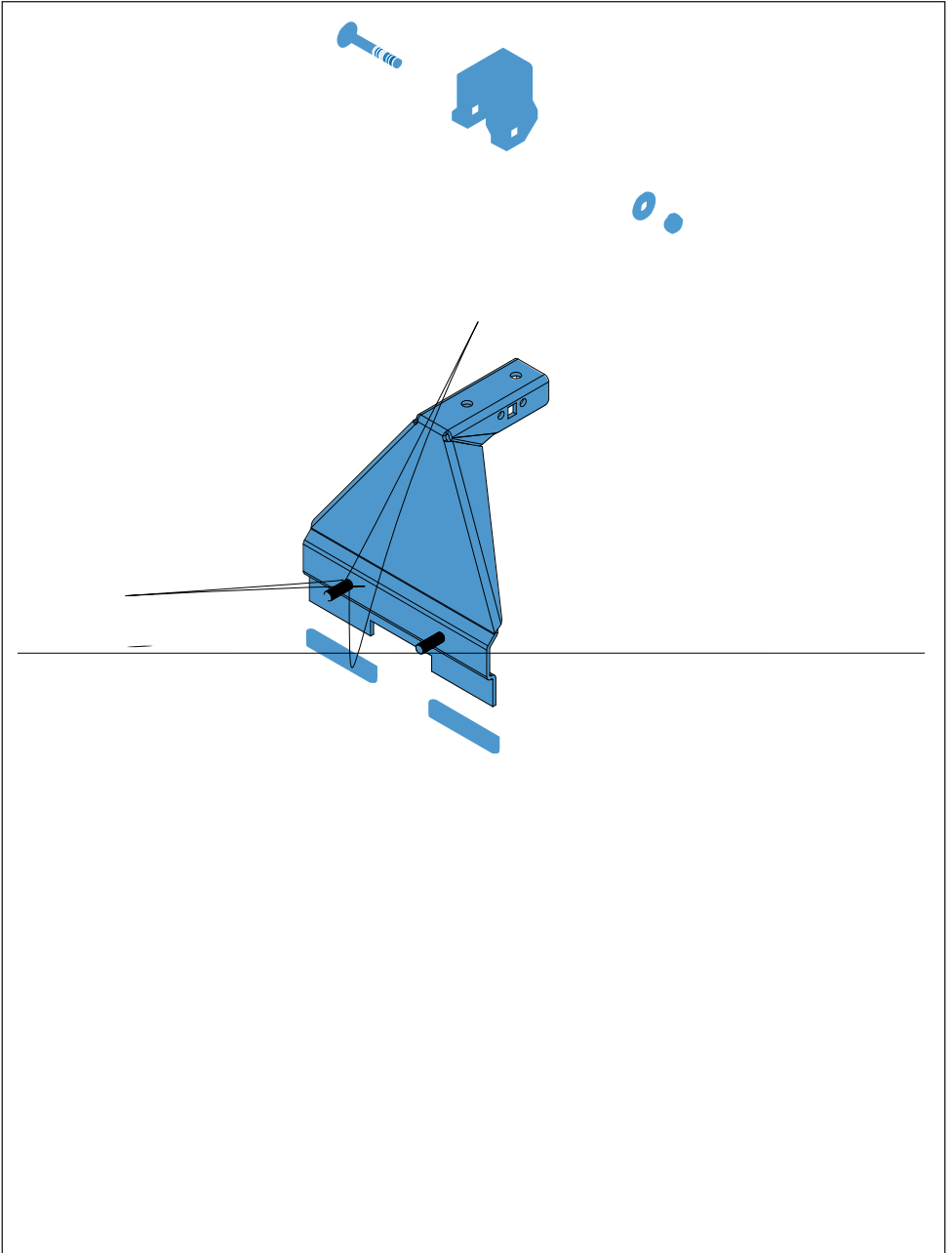

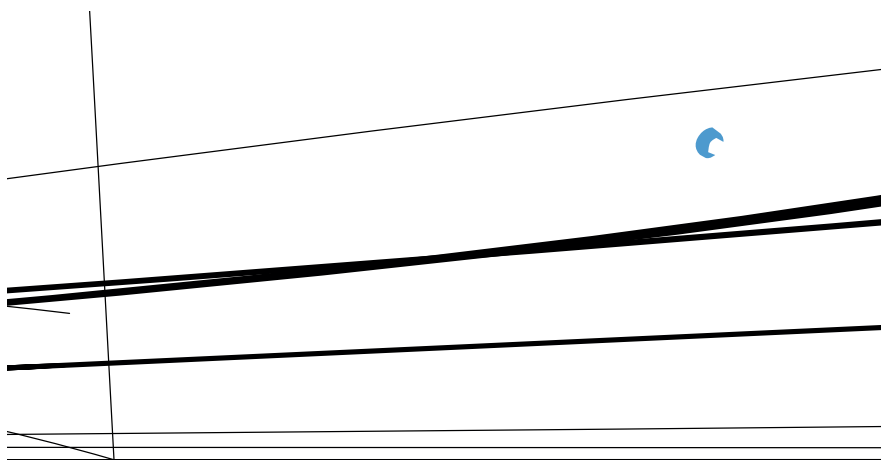

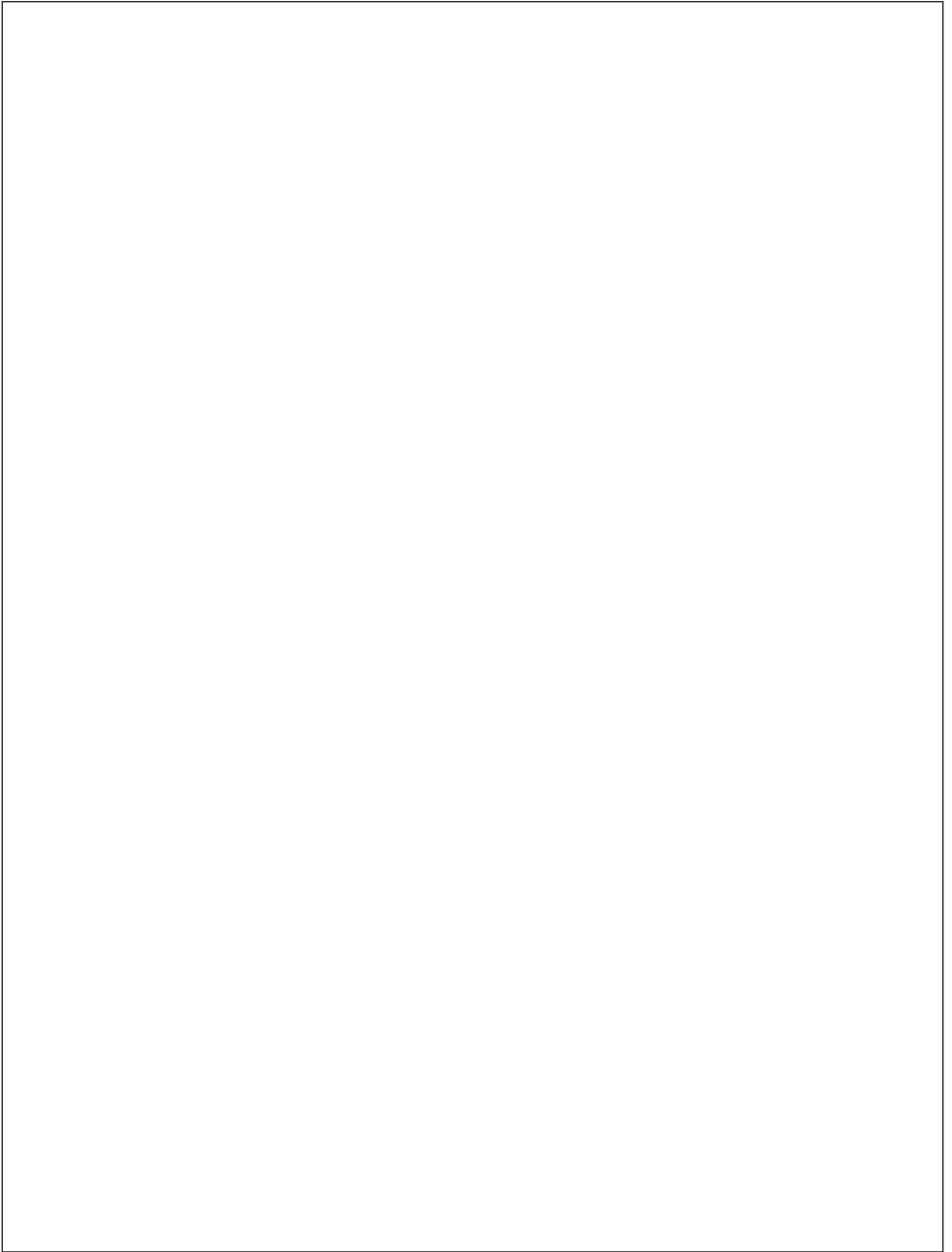

11.

